

# PORTA

## NBA-PO1800

alta  
by 



BASE CABINET PLAN

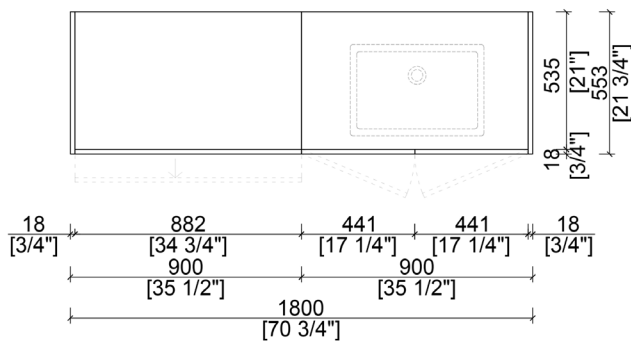

FRONT ELEVATION

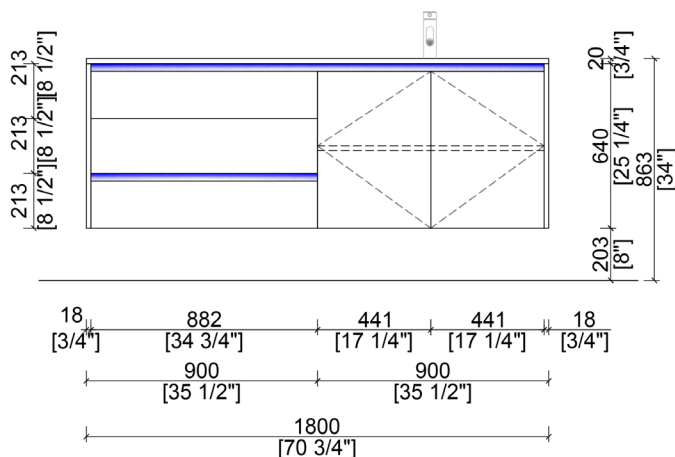

### FEATURES

- Simple and Clean Modular Design
- Floating wall-mount installation or floor mount models available
- Combination of swinging doors and drawers
- Integrated profile door pulls or surface mount pulls available

### AVAILABLE FINISHES

- Available in a wide variety of lacquer, melamine, and natural wood veneer

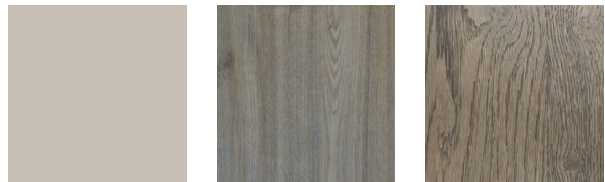

- To see the full selection of colors and finishes, please follow the link to [Cabinetry Finishes](#).