

FILO

NBTO-70



FREESTANDING BASIN INSTALLATION

THANK YOU FOR CHOOSING NELLA™

Welcome to the Nella™ family. We are confident Nella's™ superior quality, design and aesthetic will enhance your bathroom experience for many years to come. If you have any questions regarding your Nella products please contact your local sales representative or visit our website www.nellabath.com for customer support and service information.

Thank you again,
NELLA™

PRODUCT FEATURES AND DESCRIPTION

FEATURES

- NellaMar™ Solid-Surface Cultured Stone
- Seamless one-piece design
- NellaMar™ solid-surface waste cover
- Integrated overflow slot
- Matte Finish (gloss finish available)

INCLUDED COMPONENTS

- NellaMar™ solid-surface cultured stone basin
- NellaMar™ solid-surface waste cover
- Pop-up drain optional (not included)

CODES AND STANDARDS

Meets or exceeds:

- IAPMO-ANSI Z124.1
- IAPMO-ANSI Z124.3
- CSA B45.0-CSA B45.4
- cUPC



IMPORTANT - PRIOR TO INSTALLATION

Before you begin please be sure to review the steps below to ensure preferred installation results.

1. Unpack your new NELLA™ product and confirm it is the correct model ordered and inspect the product for damage. Please keep product in its original packaging until you are ready for installation.
2. Confirm that all walls are plumb and all mounting/installation surfaces are level.
3. Shut off existing water supply.
4. Confirm that your plumbing technician has the proper/recommended tools for proper installation.

FILO
NBTO-70



IMPORTANT - PRIOR TO INSTALLATION

Prior to installation please be sure to review all installation instructions with a licensed or qualified plumbing technician who is familiar with all local plumbing and building codes in your jurisdiction.

Before you begin please be sure to review the steps below to ensure preferred installation results.

Immediately upon receiving your Nella product and removing it from its packaging we strongly suggest IMMEDIATE INSPECTION of your Nella product for potential freight damage. Any claims for damage visible or hidden, must be made immediately in order for the carrier to assume full responsibility and absorb any associated costs.

If damage or defect is discovered DO NOT INSTALL your Nella product. Any claimed damage or defect to the finish of the product after the product has been installed will be excluded from any manufacturer warranty.

To ensure this product is installed properly you must use an extremely knowledgeable and experienced plumbing professional or licensed contractor.

Confirm that all walls are plumb and all mounting/installation surfaces are level.

Shut of existing water supply.

We suggest a minimum of two people perform the installation of Nella freestanding bath tubs.

Please keep this information for future reference.

If final connections are made below the finished floor - accessibility below the finished floor is recommended.

Please take the necessary precautions to protect your Nella basin. We suggest using a soft, cloth blanket to COVER THE FLOOR to rest the basin on during installation. This will ensure the product is not scratched or damaged. If the product is provided with polyethylene protective film, do not remove the film until installation is complete; however, the film should be removed prior to installation when the basin surface will permanently be touching another surface after installation (e.g. a wall)

Avoid dropping the basin during the handling to prevent chipping or damages. We recommend using rubber gripped gloves to handle.

Please inspect the basin before the installation to confirm all dimensions of the product correlate to the product specifications (nominal tolerances accepted).

FILO

NBTO-70



FREESTANDING BASIN INSTALLATION

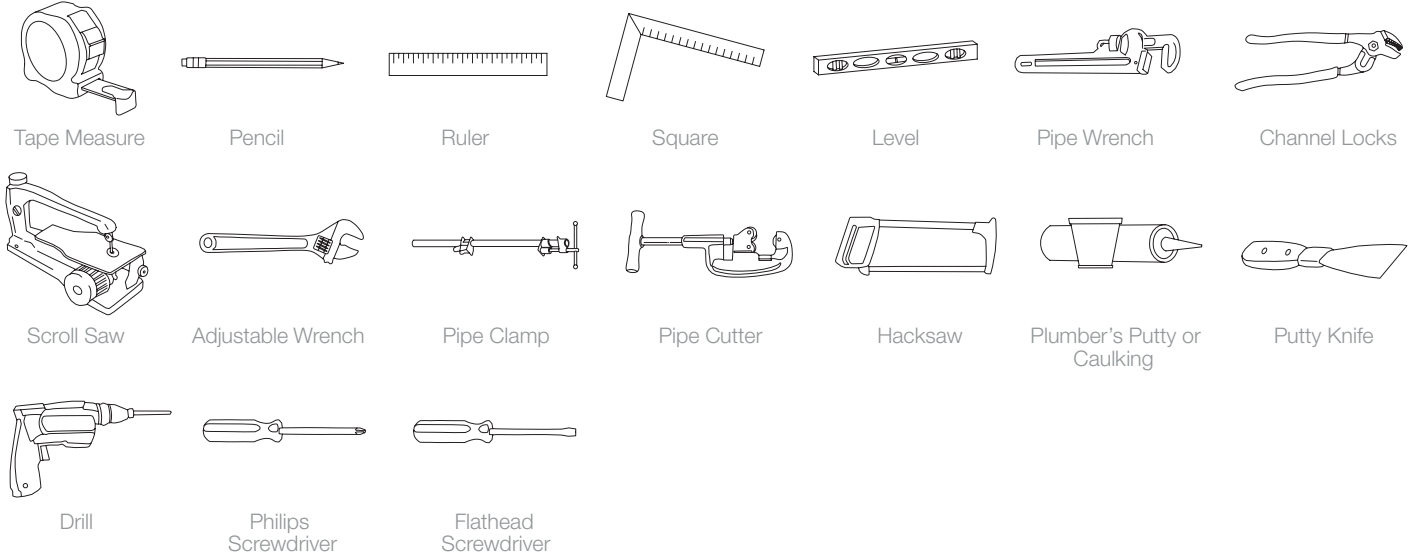

ROUGH-IN DIMENSIONS

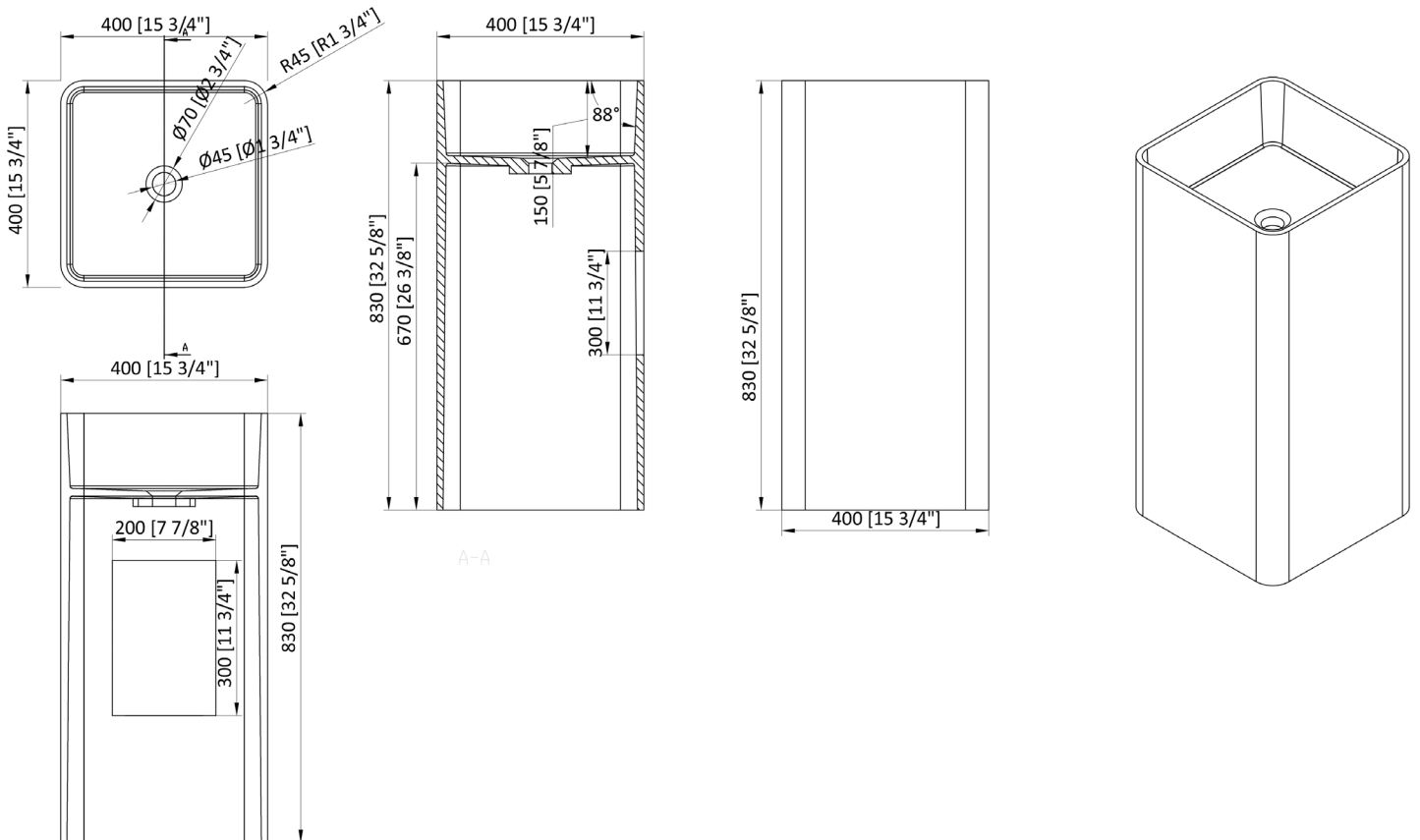

FILO

NBTO-70



FREESTANDING PEDESTAL BASIN INSTALLATION INSTRUCTIONS

1. Specify and confirm the basin location in the room.

A 3" gap/space is recommended between the basin and the finished wall. This will allow for easier access to plumbing fixtures in the future, and also make installation easier.

2. Be sure your main, rough-plumbing waste pipe is located and installed at the proper height.

****IMPORTANT**** - Be sure your rough-plumbing outlet has been installed at a height that will align with the waste opening on the back of the basin.

3. Screw a flanged tail piece to the pop-up drain inside the cavity of the basin. Access is provided through the waste opening on the back of the basin. Flanged tail-piece should be tall enough so that it is accessible through the waste opening on the back of the basin.

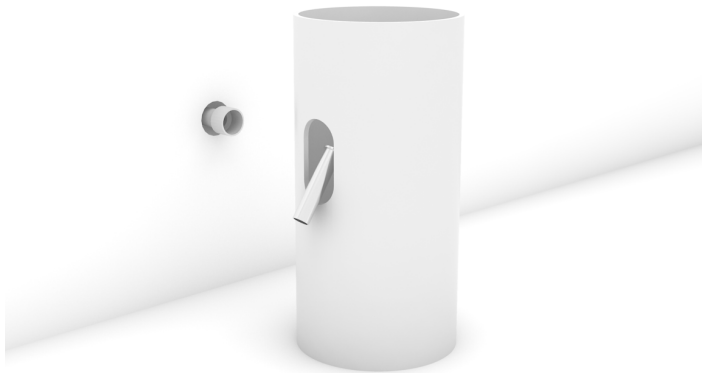

4. Connect a P-Trap to the flanged tail piece so that it produces out of and past the inner cavity of the basin.

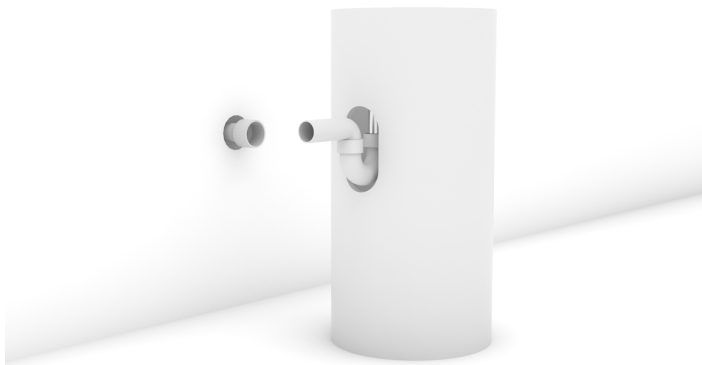

5. Rotate the basin so that the waste opening is facing your finished wall. Be sure you P-Trap aligns with your rough-plumbing outlet and they are both at the same height in order to make the proper connection.

6. Push the basin towards the finish wall and connect the P-Trap to the rough-plumbing outlet in the wall.

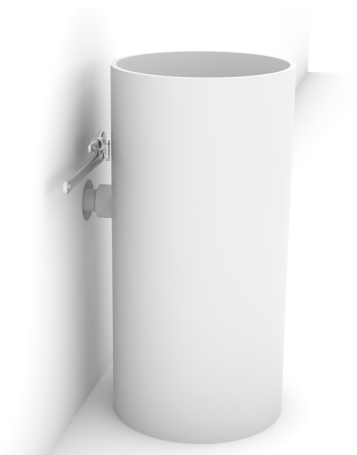

Tighten the two together securely.



7. Apply a thick bead of adhesive silicone caulking to the base of basin where it meets the floor.



FILO

NBTO-70



FREESTANDING PEDESTAL BASIN INSTALLATION INSTRUCTIONS - WITH MOUNTING CLIPS

1. Specify and confirm the basin location in the room. Using a pencil or marker trace the exterior line of the base of the basin.

A 3" gap/space is recommended between the basin and the finished wall. This will allow for easier access to plumbing fixtures in the future, and also make installation easier.

****IMPORTANT**** - Mark the location of the installation access openings on each side of the basin and mark their location on the floor.

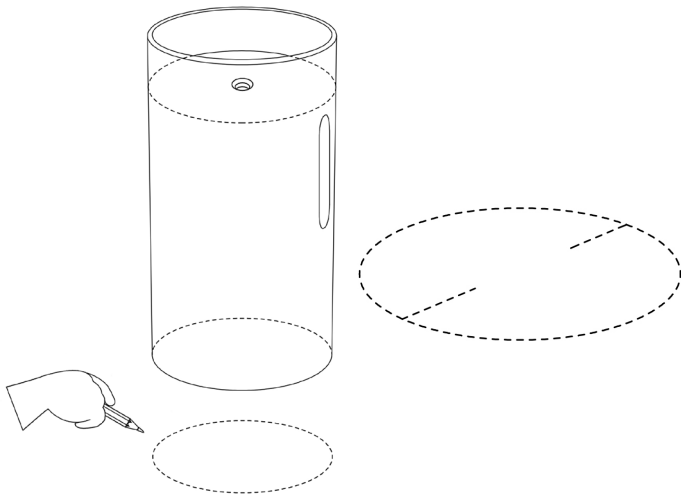

This line will be your future reference for placement and will also help you confirm your floor-bracket location.

2. After the outline of the base has been marked, measure 1/2" (12mm) inside of the outline. This will be the location at which the floor-brackets are installed.

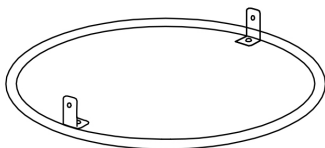

3. Place the floor-brackets on the floor as shown below and fasten the brackets to the floor.

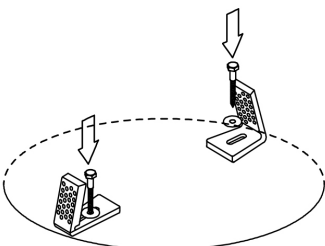

****IMPORTANT**** -

Be sure your rough-plumbing outlet has been installed at a height that will align with the waste opening on the back of the basin.

Insert pop-up drain into the drain outlet and secure properly in place.

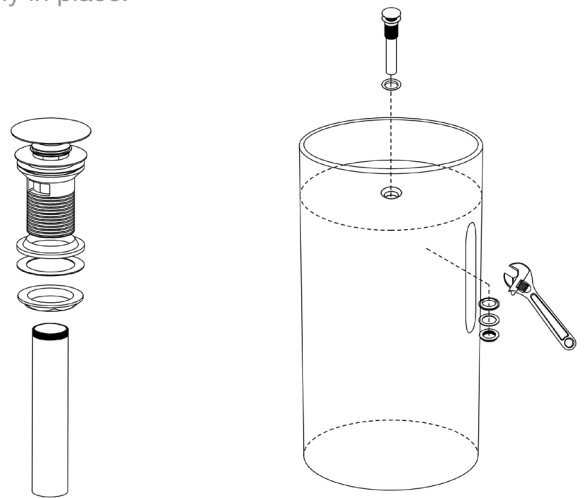

4. Screw a flanged tail piece to the pop-up drain inside the cavity of the basin. Access is provided through the waste opening on the back of the basin. Flanged tail-piece should be tall enough so that it is accessible through the waste opening on the back of the basin.

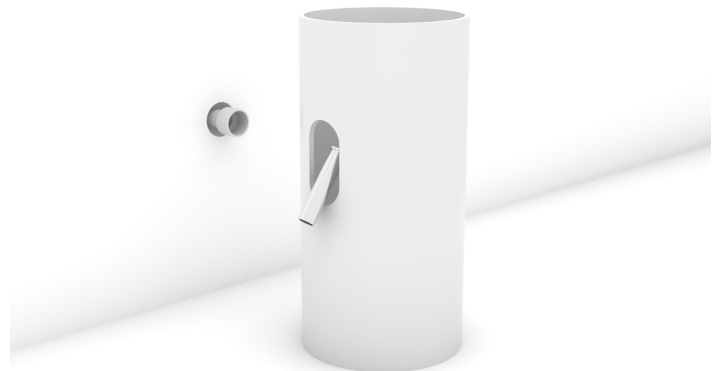

FILO

NBTO-70



FREESTANDING PEDESTAL BASIN INSTALLATION INSTRUCTIONS - WITH MOUNTING CLIPS

5. Connect a P-Trap to the flanged tail piece. Be sure the P-Trap protrudes enough past the inner cavity of the basin, in order to make access and connection to the main, rough-plumbing easier.

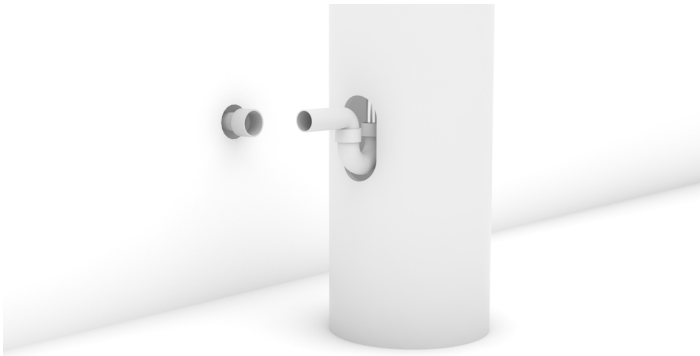

6. Rotate the basin so the back is facing towards the finish wall. Lift the basin and then lower it down into position using your outline (from step 1.) as a reference.

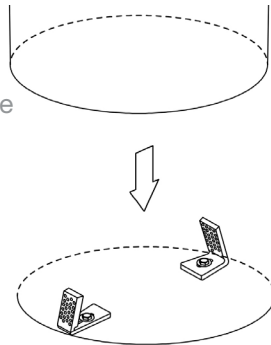

Be sure the waste opening is facing the finished wall and your P-Trap height and align your rough-plumbing outlet are aligned in order to make the proper connection.

****IMPORTANT** -**

Be sure the installation access openings on each side of the basin are aligned with the floor-brackets.

7. Connect the P-Trap to the rough-plumbing outlet in the wall.

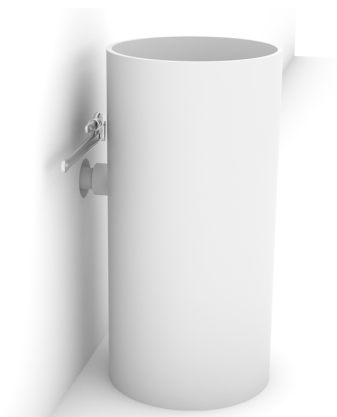

Tighten the two together securely.



8. Fasten the basin to the brackets through the installation access openings with the provided fasteners.

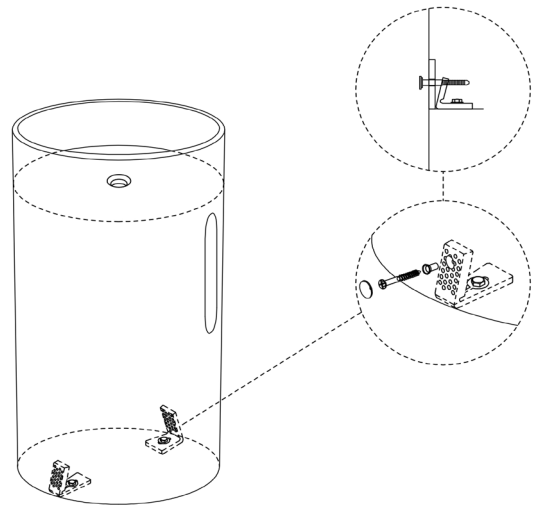

9. Apply a thick bead of adhesive silicone caulking to the base of basin where it meets the floor.

