

# LARES

## NBDO-34020



### FREESTANDING BATHTUB FILLER INSTALLATION INSTRUCTIONS

#### THANK YOU FOR CHOOSING NELLA™

Welcome to the Nella™ family. We are confident Nella's™ superior quality, design and aesthetic will enhance your bathroom experience for many years to come. If you have any questions regarding your Nella products please contact your local sales representative or visit our website [www.nellabath.com](http://www.nellabath.com) for customer support and service information.

Thank you again,  
NELLA™

#### PRIOR TO INSTALLATION

Prior to installation please be sure to review all installation instructions with a licensed or qualified plumbing technician who is familiar with all local plumbing and building codes in your jurisdiction.

#### PRODUCT FEATURES AND DESCRIPTION

##### FEATURES

- Solid brass construction
- Brushed nickel or polished chrome finish
- Single-hand lever volume and temperature control (3.79gpm @ 20psi) / Calgreen optional
- Handheld shower wand (2.33gpm @ 80psi) / Calgreen optional
- Integrated diverter
- Neoperl™ aerator
- Sedal Ceramic cartridge

##### INCLUDED COMPONENTS

- Solid brass freestanding bath filler
- Handheld shower wand with supply hose
- Water supply hoses
- Floor-mount installation kit

##### CODES AND STANDARDS

Meets or exceeds:

- ANSI / ASME standard A112.18.1 and CAN / CSA B125.1-05 requirements
- cUPC
- California AB1953 compliant
- Calgreen compliant

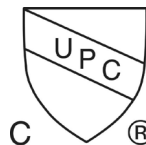

*CAL*Green





---

## **FREESTANDING BATHTUB FILLER INSTALLATION INSTRUCTIONS**

---

### **IMPORTANT - PRIOR TO INSTALLATION**

Immediately upon receiving your Nella bath product and removing it from its packaging we strongly suggest IMMEDIATE INSPECTION for potential freight damage. Any claims for damage visible or hidden, must be made immediately in order for the carrier to assume full responsibility and absorb any associated costs.

If damage or defect is discovered DO NOT INSTALL your Nella product. Any claimed damage or defect to the finish of the product after the product has been installed will be excluded from any manufacturer warranty.

To ensure this product is installed properly you must use a licensed contractor or extremely experienced plumbing professional.

Please keep this information for future reference.

All final connections are made below the finished floor - accessibility below the finished floor is recommended.

Please take the necessary precautions to protect your Nella product.

# LARES

## NBDO-34020



### FREESTANDING BATHTUB FILLER INSTALLATION INSTRUCTIONS

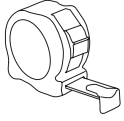

Tape Measure



Pencil



Ruler

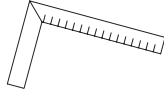

Square



Level

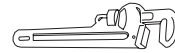

Pipe Wrench

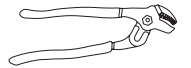

Channel Locks

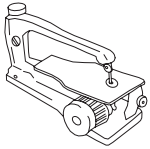

Scroll Saw



Adjustable Wrench

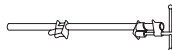

Pipe Clamp

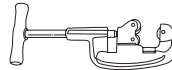

Pipe Cutter

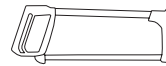

Hacksaw

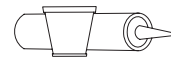

Plumber's Putty or  
Caulking



Putty Knife

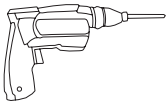

Drill



Phillips  
Screwdriver



Flathead  
Screwdriver

### ROUGH-IN DIMENSIONS

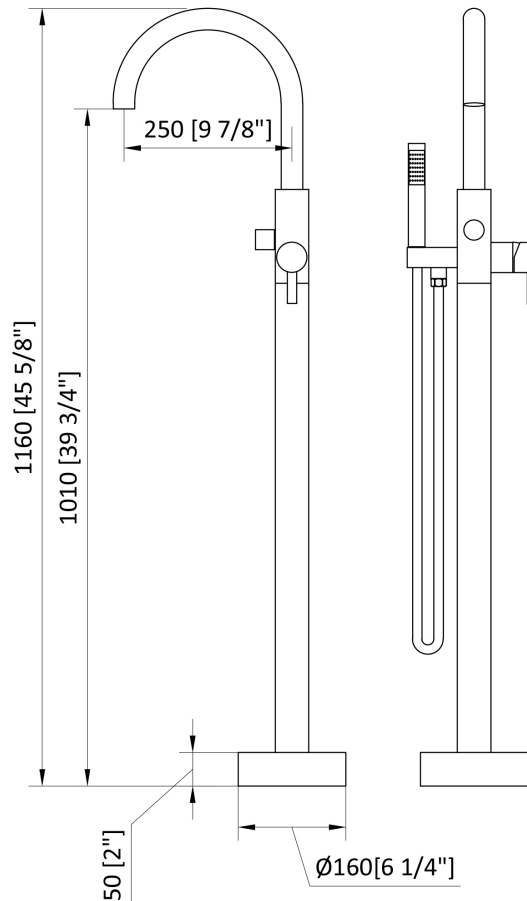

# LARES

NBDO-34020



## FREESTANDING BATHTUB FILLER INSTALLATION INSTRUCTIONS

### ILLUSTRATED PARTS LIST

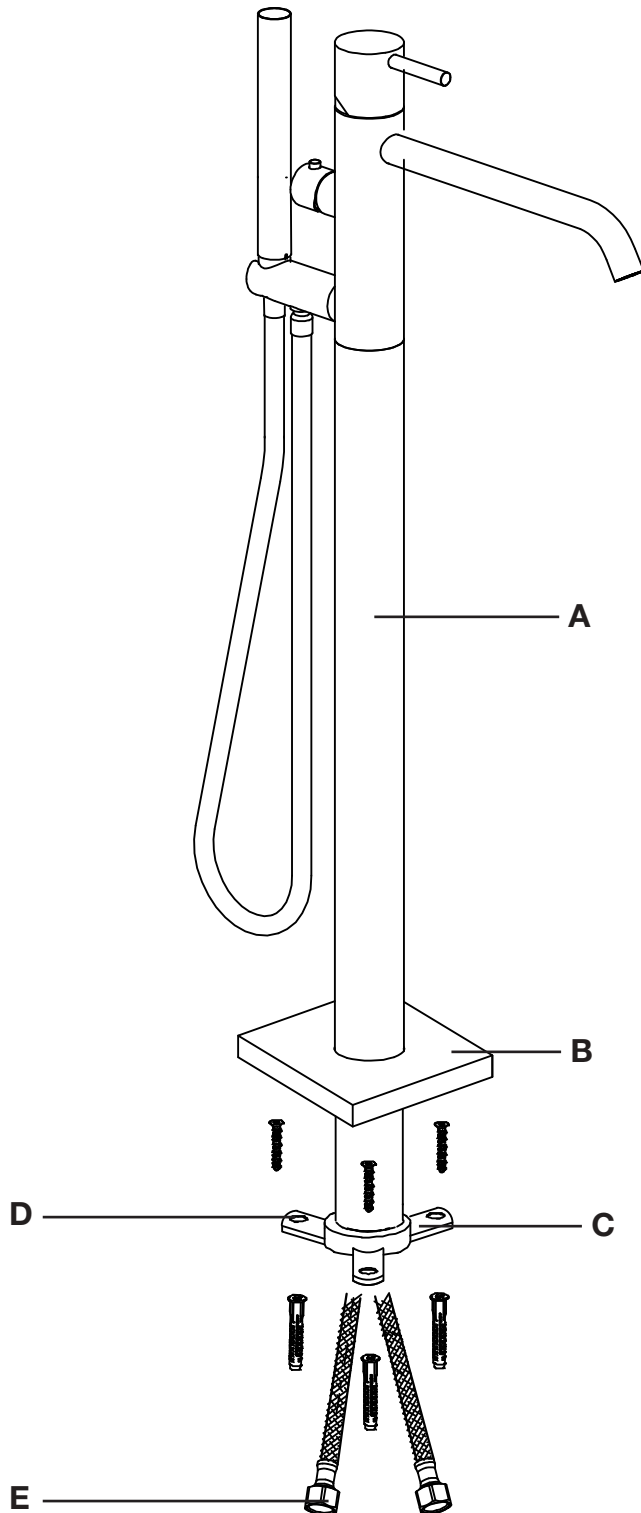

- A. Supply Column
- B. Column Anchor Cover
- C. Column Anchor
- D. Screw Locations
- E. Hot and Cold Water Supply

## FREESTANDING BATHTUB FILLER INSTALLATION INSTRUCTIONS

### INSTALLATION INSTRUCTIONS

#### Confirm bathtub position in room

Prior to installing the bathtub filler -- the bathtub location must be confirmed.

Once the bathtub location has been confirmed, proceed to confirm the tub filler location.

#### Installing floor blocking

Depending on existing floor conditions, floor blocking is recommended.

2" x 6" lumber should be fastened to the floor joist to provide added strength and rigidity to the subfloor.

Once blocking is in place -- be sure to create an opening in the blocking for the main hot and cold water supply.

The opening created for the main hot and cold water supply should not exceed diameter of the anchor plate inlet.

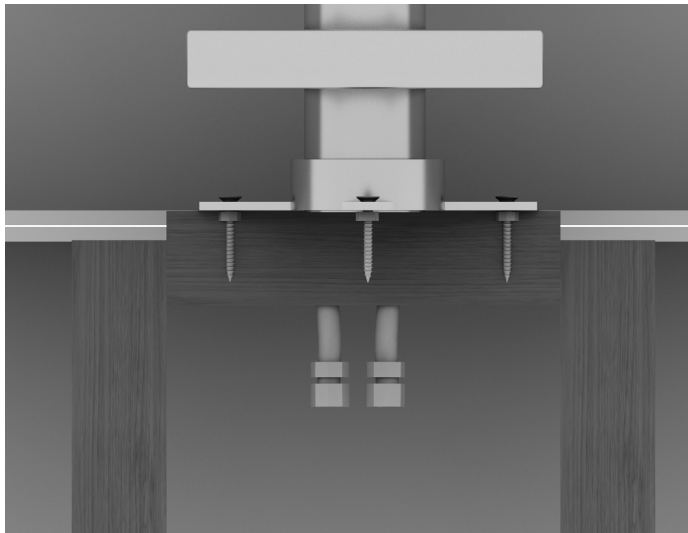

#### Installing the tub filler

Place the supply column (A) in the desired installation position.

Raise the column anchor cover (B) and expose the column anchor so it is fully accessible.

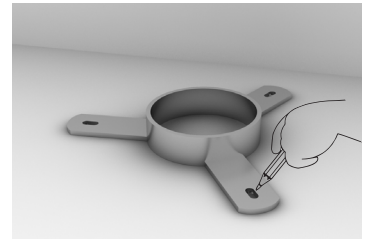
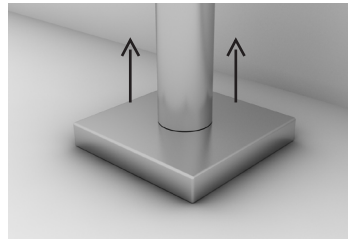

Place the column anchor (C) in its confirmed position and proceed to mark the screw locations (D) through the screw holes with a pen or pencil.

**\*\*NOTE:** In some conditions, connecting the main hot and cold water supply (E) to the tub filler water hoses prior to fastening the column anchor in place, can make installation easier. \*\*

With the column anchor in place, proceed to fastening the screws into the floor and secure the column anchor in place

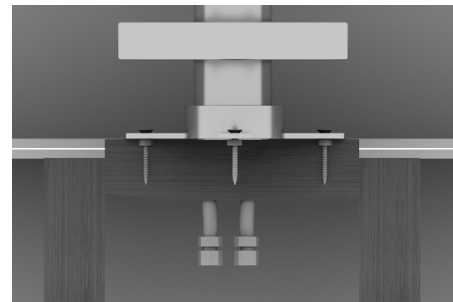

Be sure water connections are tight and there is no leakage.

Once water column installation and water connections have been completed, proceed to lower the column anchor cover so that it meets the floor -- covering all connections and rough plumbing.

